

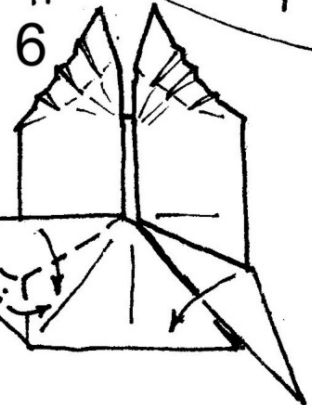

Christmas Tree Fairy

by Dave Brill

Start with a 30 cm square
colour side up

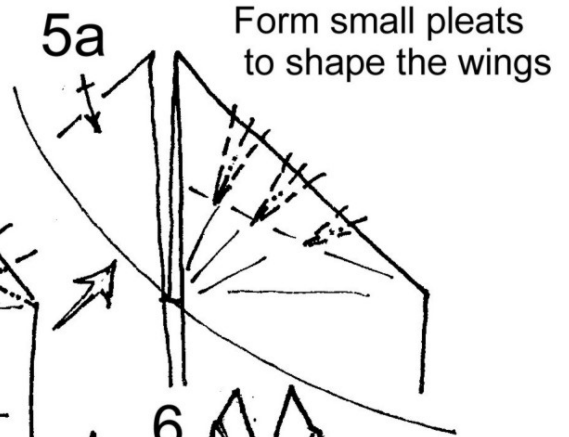
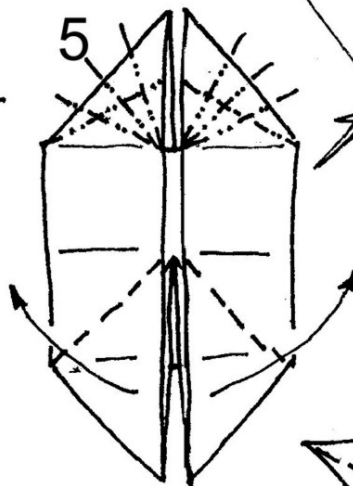
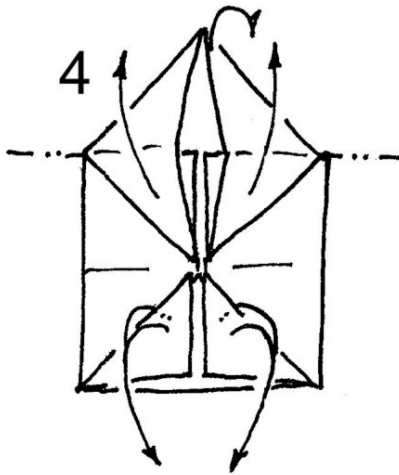
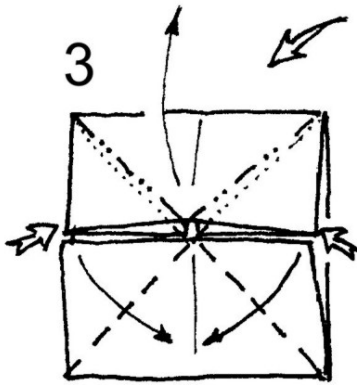
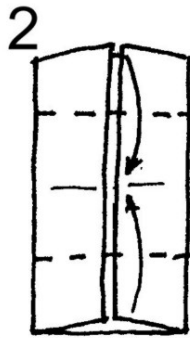
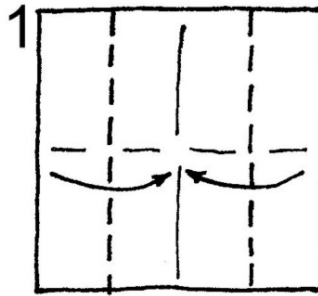

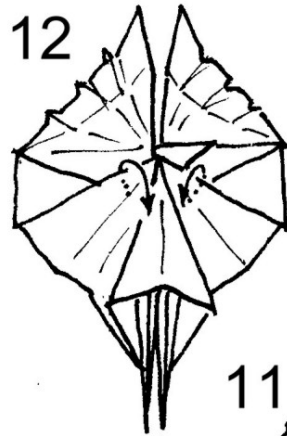

12

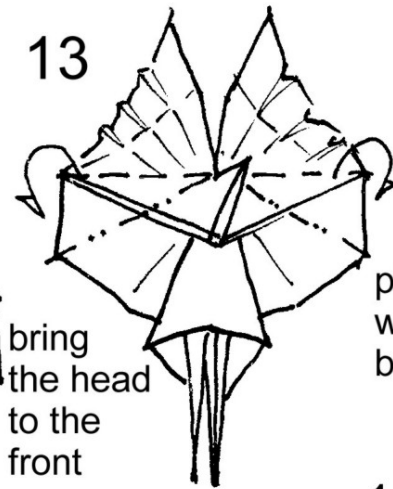

13

bring the head to the front

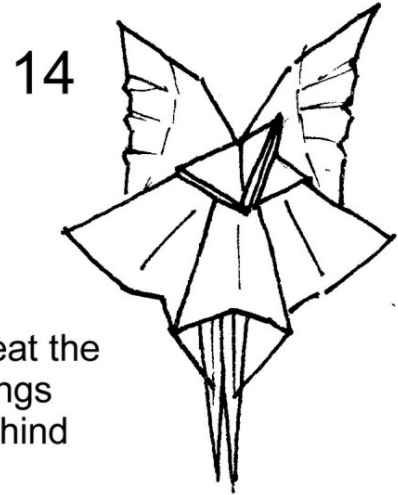

14

pleat the wings behind

swing the legs together and release layers behind

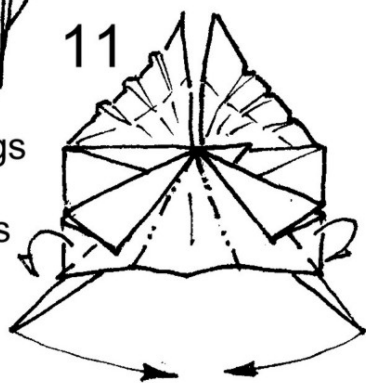

11

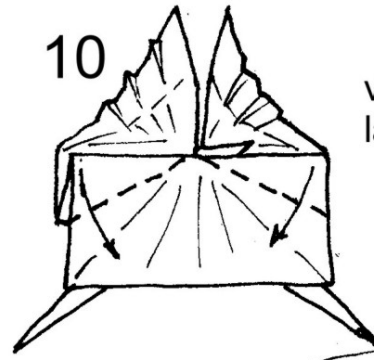

10

valley fold double layers each side



9a

release layers to change the hair colour

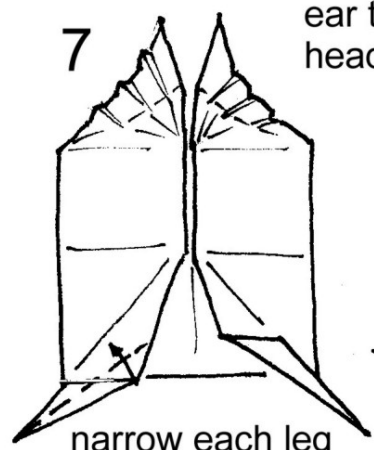

7

narrow each leg with valley folds

rabbit ear the head

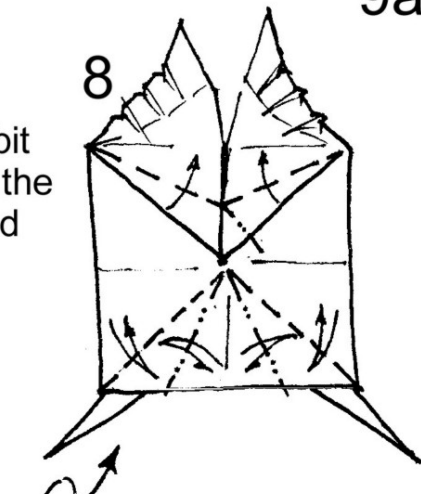

8

precrease the skirt

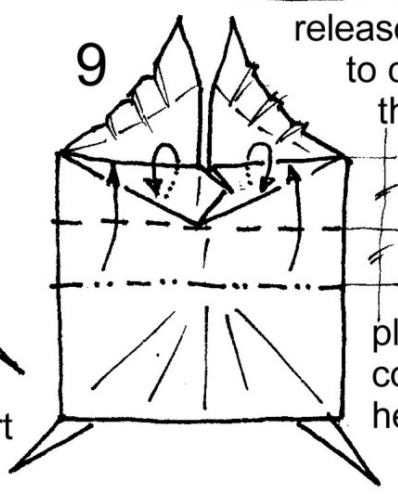

9

pleat to cover the head flap

15 separate and gently squash the layers of the head flap

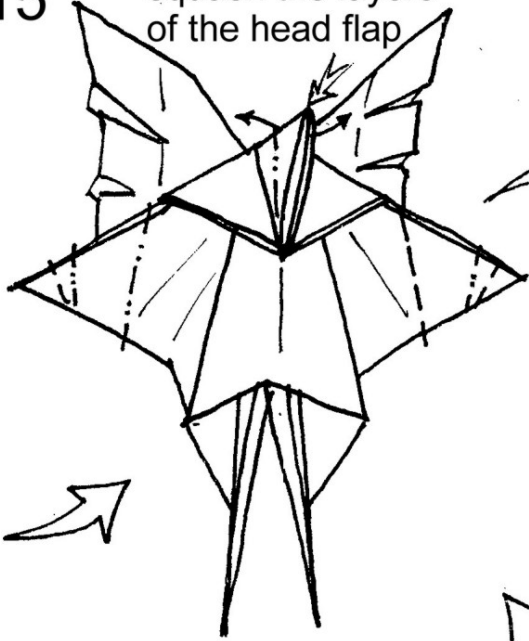

16 open and shape the head and hair

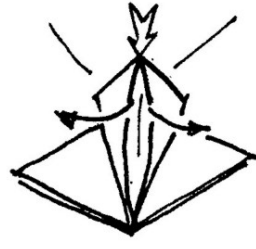

17

